

STC-795T-AL

7" Touch Panel PC

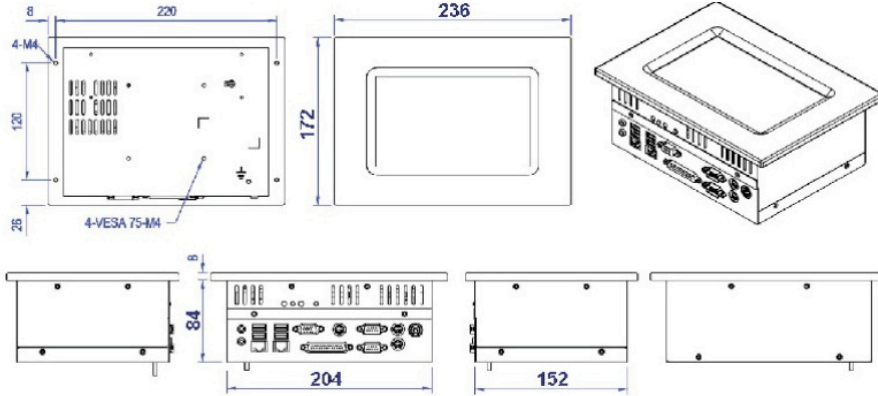

Specifications

System:

CPU (Standard): Intel 65 nm, Yonah Mobile high speed 1.6 GHz with 1 M L2

-Option 1: Intel 65 nm Mobile 1.86 GHz with 1M L2 cache memory

-Option 2: Intel 65 nm Core Dual Mobile 2 GHz with 2M L2 cache

Memory (Standard): DD R2-667 M High Speed 512 MB RAM (Option: 1G, 2G, 4GB)

HDD (Standard): Slim anti-shock high speed 80G SATA HD (Option: 120G, 160G)

SDD (CF or DOM): CF 1G, 2G, 4G, 8G or DOM 1G, 2G, 4G, 8G Solid State flash disk

Watchdog Timer: 1-255 seconds programmable (enable through BIOS)

LCD Display:

Size/Resolution: 7" TFT Color LCD, 800 x 600 pixels

Luminance (Standard): 400 cd/m2, long-life LED backlight, 800 x 480, 262, 144 colors

I/O:

Serial (COM) Port: 2 x COM (1 x RS-232 + 1 RS232/422/485) (total 6 x COM)

USB 2.0 Port: 4 X USB 2.0 accessible at the I/O area (total 8)

LAN: 2 ultra high-speed Giga bit 10/100/1000 Mbps Ethernet

TV-out: Export image or data to a TV screen

KB/MS/Printer: 1 x PS2 KB, 1 x PS2 Mouse, 1 x Printer port

Expansion Slot: 1 x PCI slot (optional), 1 x CF socket, 1 x DOM socket

Digital IO (option): 8 x Digital Inputs, 8 x Digital Outputs, or 4 x D.I. plus 4 x D.O.

IP-65 / NEMA-4 Water-Resistant Rating:

IP-65 Rating: Meets IP-65, NEMA-4 Ratings at front (steel bezel)

IP-68 Rating: Meets IP-65, 66, 67, 68, NEMA-4 Ratings at front (aluminum bezel)

Touch Screen: Optional

Long life 5-wire analog resistive touch screen

Resolution: 4096 x 4096

Touch life: 10,000,000 touch times

Mechanical & Environmental:

Operating Temp: 0~60 degrees Celsius

Storage Humidity: 5~95 % non-condensing

Vibration: 17 to 500Hz, 3G peak to peak

Shock: 20G / peak (11m sec)

Construction: Heavy-duty rugged Steel + Aluminum Front Bezel

Wall Mounting: VESA-75 Compatible

Panel Mounting: Panel mounting supported

Video Function:

Dual Independent Display: Support Dual Independent Display with 2 different images

VGA (DVI): Support second monitor, (DVI is optional)

3D Graphics: GMA 950 engine supports 3D/2D high-speed graphics

Ordering Information:

STC-795T-AL: Intel 1.6G CPU, 512M, 80G HD, Touch, aluminum bezel

STC-795T: Intel 1.6G CPU, 512M, 80G HD, Touch, steel bezel

Scriptel Corporation
4153 Arlingate Plaza
Columbus, OH 43228 USA
+1 614.276.8402
+1 614.276.7615 Fax
www.scriptel.com